



Aserman Technology TM

GLASSEXCEL

architecture hardware





is always striving to ensure customer satisfaction by providing the market place with high quality products at competitive pricing. Our specialty hardware, through thoughtful consideration is designed to meet the needs of almost all of our customers design requirements while maintaining real world functionality. Upholding these high standards allow our firm to establish lasting relationships with our clients, whether you are building your own home or a grand development.

It is our goal to exceed your expectations.



Table of Content

01	Floor Slings	12	Carry Fitting
02	Combo Patch Set	13	Profile Telescopic Sliding System
02	Hydraulic Patch	14	Profile Synchronized Sliding System
03-04	Patch Fitting	14	Profile Telescopic Sliding System Acc.
05	Glass Connectors	15	Spider Fitting
06	Shower Hinges	16	Fix Plates, Splice Plates, Routers
07	Plastic Profiles	17-18	Door Handles
07	Shower Knight Head Acc.	18	Shower Door Handles, Door Knobs
08	Shower Sliding System	19	Glass Rating Acc.
08	Sliding Door System	19	Aluminum-Glazing Profile
09	Office Sliding System Set & Acc.	19	Profile Fixed Profile, Min Hinges
10	Sliding Door Track	20	SS Friction Stay Hinge
10	Jaguar Sliding System	20	Aluminum Door Handle
10	Automatic Sliding Screen Door	20	Self Taping Screws, Vacuum Lifter
11	Sliding Folding System	20	Double Sided Structural Glazing Tape
11	Center Sliding Folding System	20	Door Clear
12	Locks without Cutout	20	Mitering Tool



Floor Spring

TESTED TO 100000 CYCLES



ZFS-848
Double Spring Floor Hinge

Solid Spring



Specification

- Size 1 (1.25) inch wide
- Service design - suitable for left or right hand doors
- Operates with 1/2" square and ball ends
- General hardware finish
- Heavy duty floor
- Maximum plate size 10" x 10" (254x254mm)
- Maximum door weight 150kg
- Heavy coating suitable for high salt/acid environments
- Location of set screw

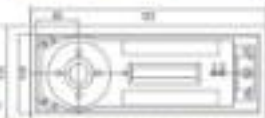

TESTED TO 500000 CYCLES



ZFS-748
Double Spring Floor Hinge



Specification

- Size 1 (1.25) inch wide
- Service design - suitable for left or right hand doors
- Operates with 1/2" square and ball ends
- General hardware finish
- Heavy duty floor
- Maximum plate size 10" x 10" (254x254mm)
- Maximum door weight 150kg
- Heavy coating suitable for high salt/acid environments
- Location of set screw

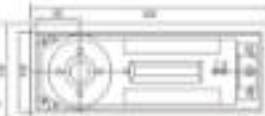

TESTED TO 500000 CYCLES



ZFS-648
Double Spring Floor Hinge



Specification

- Size 1 (1.25) inch wide
- Service design - suitable for left or right hand doors
- Operates with 1/2" square and ball ends
- General hardware finish
- Heavy duty floor
- Maximum plate size 10" x 10" (254x254mm)
- Maximum door weight 150kg
- Heavy coating suitable for high salt/acid environments
- Location of set screw

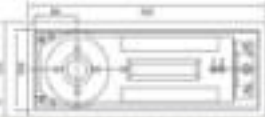

TESTED TO 500000 CYCLES



ZFS-448
Single Spring Floor Hinge



Specification

- Size 1 (1.25) inch wide
- Service design - suitable for left or right hand doors
- Operates with 1/2" square and ball ends
- General hardware finish
- Heavy duty floor
- Maximum plate size 10" x 10" (254x254mm)
- Maximum door weight 150kg
- Heavy coating suitable for high salt/acid environments
- Location of set screw

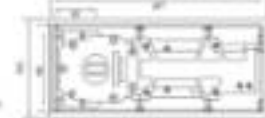

ZPL400-TRIP
By Pushbutton For
Fire Door/Smoke Door

Combo Patch Set

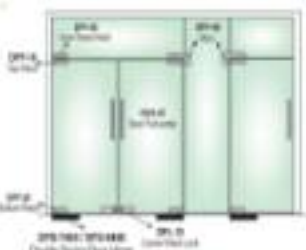
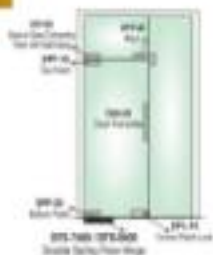

Hydraulic Patch

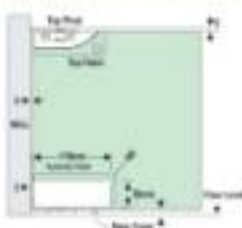

Minimum gap: 10mm
 Maximum gap: 10mm
 Minimum gap: 10mm
 Maximum gap: 10mm

Hydraulic Patch Combo Set



Patch Fittings



SPF-10
Top Panel



See Guide to SPF-10



SPF-20
Bottom Panel

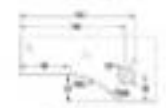

See Guide to SPF-20



SPF-30
Side Panel - Right

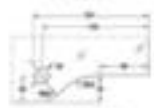

See Guide to SPF-30



SPF-40
Top L



See Guide to SPF-40



SPF-50
Down Panel - Left with Side Panel

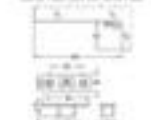

See Guide to SPF-50



SPF-60
Top L with Right

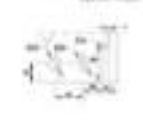

See Guide to SPF-60 L & SPF-60 R



SPF-70
Top L with Top



SPF-80
Double Down Panel - Right with Top

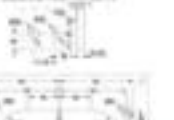

See Guide to SPF-80



SPF-90
Top

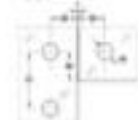

See Guide to SPF-90



SPF-100
Double Panel - Right



See Guide to SPF-100 R



SPF-110
Double Panel - Right - Concealed Edge



See Guide to SPF-110 R



SPF-120
Double Down Panel



See Guide to SPF-120



SPF-130
Double Panel - Left

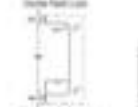

See Guide to SPF-130



SPF-140
Down Panel - Right

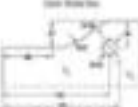

See Guide to SPF-140



SPF-150
Top - Left



See Guide to SPF-150



SPF-160
Double



See Guide to SPF-160



SPF-170
Top with Top - Right

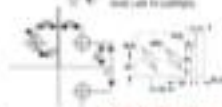

See Guide to SPF-170 R

Patch Fittings



SP-400
Standard Patch



See Data for SP-400



SP-400
Combined with G



See Data for SP-400



SP-400
Patch Glass Combined with P



See Data for SP-400



SP-400
Patch Glass Combined with P and G



See Data for SP-400



SP-400
With Floor Slips



See Data for SP-400



SP-400-ASP
For Patch to Patch Slips



See Data for SP-400-ASP



SP-400
Glass Door Slips



Glass Connectors



SSC-1
L Connector



SSC-1
L Connector



Material: Stainless Steel 316
Clear Thickness: 4mm-12mm
Finish: Chrome Plated
MS Coated to Prevent Glass
Self-Damage



SSC-2
Glass to Glass 120°



SSC-2
Glass to Glass 120°



Material: Stainless Steel 316
Clear Thickness: 4mm-12mm
Finish: Chrome Plated
MS Coated to Prevent Glass
Self-Damage

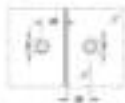

SSC-3
Glass to Glass 90°



SSC-3
Glass to Glass 90°



Material: Stainless Steel 316
Clear Thickness: 4mm-12mm
Finish: Chrome Plated
MS Coated to Prevent Glass
Self-Damage



SSC-4
L Connector



SSC-4
L Connector



Material: Stainless Steel 316
Clear Thickness: 4mm-12mm
Finish: Chrome Plated
MS Coated to Prevent Glass
Self-Damage



SSC-5
Glass to Glass 120°



SSC-5
Glass to Glass 120°

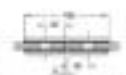

Material: Stainless Steel 316
Clear Thickness: 4mm-12mm
Finish: Chrome Plated
MS Coated to Prevent Glass
Self-Damage



SSC-6
T Connector Glass to Glass 90°

Material: Stainless Steel 316
Clear Thickness: 4mm-12mm
Finish: Chrome Plated
MS Coated to Prevent Glass
Self-Damage



Shower Hinges

Brass Hinges

ES Super Fire Hinges



220-1
1/2" x 1/2" x 17" Hinge



220-1
1/2" x 1/2" x 17" Hinge

See Technical Spec Sheet
Height: 170
Finish: Satin Chrome Plated
With Lock or Privacy Glass
See Catalog



220-2
3/4" x 1/2" x 17" Hinge



220-2
3/4" x 1/2" x 17" Hinge

See Technical Spec Sheet
Height: 180
Finish: Satin Chrome Plated
With Lock or Privacy Glass
See Catalog

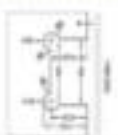

220-3
3/4" x 1/2" x 17" Hinge



220-3
3/4" x 1/2" x 17" Hinge



See
Technical Spec Sheet
Height: 180
Finish: Satin Chrome Plated
With Lock or Privacy Glass
See Catalog

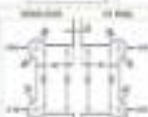

220-4
3/4" x 1/2" x 17" Hinge



220-4
3/4" x 1/2" x 17" Hinge

See Technical Spec Sheet
Height: 180
Finish: Satin Chrome Plated
With Lock or Privacy Glass
See Catalog

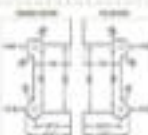

220-5
1/2" x 1/2" x 17" Hinge



220-5
1/2" x 1/2" x 17" Hinge

See Technical Spec Sheet
Height: 170
Finish: Satin Chrome Plated
With Lock or Privacy Glass
See Catalog

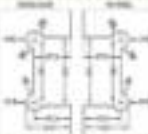

220-6
1/2" x 1/2" x 17" Hinge



220-6
1/2" x 1/2" x 17" Hinge

See Technical Spec Sheet
Height: 170
Finish: Satin Chrome Plated
With Lock or Privacy Glass
See Catalog



220-7
1/2" x 1/2" x 17" Hinge

See Technical Spec Sheet
Height: 170
Finish: Satin Chrome Plated
With Lock or Privacy Glass
See Catalog



Plastic Profiles (2.146)



SP6-1 (Flat Seal)
 Item (2.146)
 Item (2.146)
 Item (2.146)



SP6-2 (Corner Seal)
 Item (2.146)
 Item (2.146)
 Item (2.146)



SP6-3 (Control Seal)
 Item (2.146)
 Item (2.146 & 2.146)
 Item (2.146 & 2.146)



SP6-4 (D Seal)
 Item (2.146)
 Item (2.146 & 2.146)
 Item (2.146 & 2.146)



SP6-5 (Sliding Door Seal)
 Item (2.146)
 Item (2.146 & 2.146)
 Item (2.146 & 2.146)



SP6-7 (New Designed)
 Item (2.146)
 Item (2.146)
 Item (2.146)

Magnetic Profiles (2.146)



SP6-M1 (1047)
 Item (2.146)
 Item (2.146 & 2.146)
 Item (2.146 & 2.146)



SP6-M2 (1117)
 Item (2.146)
 Item (2.146 & 2.146)
 Item (2.146 & 2.146)



SP6-M3 (1017)
 Item (2.146)
 Item (2.146 & 2.146)
 Item (2.146 & 2.146)



Shower Knight Head Accessories Round Series Dia30mm



SP6-1 (Round)
 Item (2.146)



SP6-2 (Round)
 Item (2.146)



SP6-3 (Round)
 Item (2.146)



SP6-4 (Round)
 Item (2.146)



SP6-5 (Round)
 Item (2.146)



SP6-6 (Round)
 Item (2.146)

Square Series Dia 25mm



SP6-11 (Square)
 Item (2.146)



SP6-12 (Square)
 Item (2.146)



SP6-13 (Square)
 Item (2.146)



SP6-14 (Square)
 Item (2.146)



SP6-15 (Square)
 Item (2.146)



SP6-16 (Square)
 Item (2.146)

Rectangle Series Dia 10x30mm



SP6-17 (Rectangle)
 Item (2.146)



SP6-18 (Rectangle)
 Item (2.146)



SP6-19 (Rectangle)
 Item (2.146)



SP6-20 (Rectangle)
 Item (2.146)

Office Sliding System Set



OSL-40-A1 (Set)
Roller (x2)

OSL-40-A1-1 (Roller)
OSL-40-A2 (Slider)
OSL-40-B (Floor Base)

Specification

- Four (4) rollers (two on each side of floor channel)
- Maximum floor load: 500 kg/m² (100 psf)
- Height-adjustable glass (thickness: 10 mm)
- Secure gap-in-freezer
- Self-aligning suspension of base
- Water-tight seal for extra protection of head
- Independently removable roller to permit clearance in track and return
- Suitable for standard 12 mm glass
- Available for zero height fixing



OSL-40-A2 (Set)
Roller (x2)

OSL-40-A2-1 (Roller)
OSL-40-A2 (Slider)
OSL-40-B (Floor Base)

Specification

- Non-sliding suspension roller
- Available for up to 10mm height of floor
- Upper surface used for attachment of the floor suspension bracket and for installation of weather seal
- Self-align for glass positioning



OSL-40-B (Set)
Floor Suspension Frame (x2)

OSL-40-A2-1 (Roller)
OSL-40-A2 (Slider)
OSL-40-B (Floor Base)

Specification

- Secure suspension and floor joint
- Depth: 50mm (2 inch)
- Depth: 50mm (2 inch)

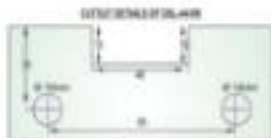

OSL-40-A1
Roller



OSL-40-A2
Roller & Floor Base



OSL-40-B
Roller & Floor Base



OSL-40-B
Floor Base



OSL-40-A1
90° Floor Connector



OSL-40-A2
90° Floor Connector



OSL-40-B
Floor Base



OSL-40-B
Floor Base

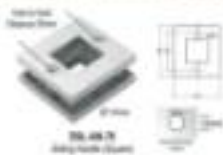

OSL-40-B
Sliding Frame Channel



OSL-40-B
Sliding Frame Channel

Sliding Folding System

Maximum weight per pane: 150kg
 Maximum height per pane: 2000mm
 Maximum width per pane: 2000mm
 * Suitable for 2 to 6mm glass thickness

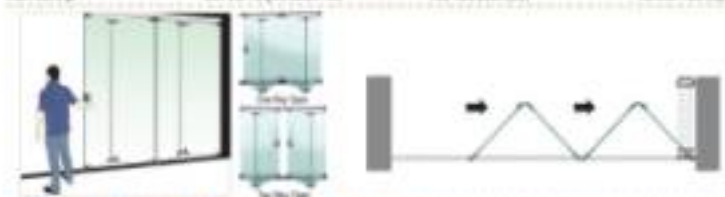

Center Sliding Folding System



Locks Without Cutout



99L-01
Single Door Lock (Dry-Prep)



99L-02
Double Door Lock (Dry-Prep)



99L-03
Single Door Lock (Dry-Prep)



99L-04
Double Door Lock (Dry-Prep)



99L-05
Single Door Lock (Dry-Prep)



99L-06
Double Door Lock (Dry-Prep)



99L-07
Single Door Lock (Dry-Prep)



99L-08
Double Door Lock (Dry-Prep)



99L-09 (1/2" Type)
Single Door Lock (Dry-Prep)



99L-10 (1/2" Type)
Double Door Lock (Dry-Prep)



99L-11
Single Door Lock (Dry-Prep)



99L-12
Double Door Lock (Dry-Prep)



Canopy Fittings



99C-1
Flat to Glass Connector



99C-2
Retrofit Glass Connector



99C-3
Marine Flat Connector



99C-4 (New)
Canopy Flat-to-Glass Connector

Profile Telescopic Sliding System (Soft Close)

Profile

Telescopic Sliding System for Two Doors, Two Doors and Single Doors, Suitable for Sliding Doors for Homes, Hotels, Office Buildings etc.
 Glass Spring, Steel Decoupler, Sliding Track, Aluminium Anodized, Hanging Roller Zinc Alloy 24.

Profile Telescopic Sliding System (Soft Close) 2+1 Telescopic System



SPS-101 (Soft Close)
Telescopic Sliding System (2 Doors)

2 Door Telescopic Anodized Set
 Sliding Top Track
 Fixed Decoupler Cover
 Top & Bottom Profile
 Side Profile
 Handle
 Glass Profile as Per Requirement

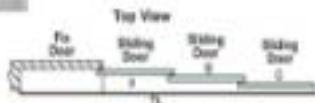

Profile Telescopic Sliding System (Soft Close) 2+1 Telescopic System



SPS-101 (Soft Close)
Telescopic Sliding System (2 Doors)

2 Door Telescopic Anodized Set
 Sliding Top Track
 Fixed Decoupler Cover
 Top & Bottom Profile
 Side Profile
 Handle
 Glass Profile as Per Requirement

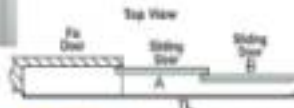

Profile Telescopic Sliding System (Soft Close) Single Door Telescopic System



SPS-102 (Soft Close)
Telescopic Sliding System (Single Door)

Single Door Telescopic Anodized Set
 Sliding Top Track
 Fixed Decoupler Cover
 Top & Bottom Profile
 Side Profile
 Handle
 Glass Profile as Per Requirement

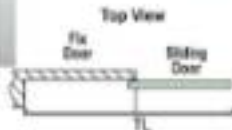

Profile Synchronized Sliding System



SPTS-100 (SST) Glass Profile Synchronized Sliding System

Synchronized Accessories Kit:
 Sliding Top Track
 Top Sash Channel Cover
 Top & Bottom Profile
 Glass Profile
 Handles
 Corner Profile as per Requirement



PROFILE TELESCOPIC SLIDING SYSTEM (ACCESSORIES FOR FITTING)



SPTS-100 Top Sliding Track



SPTS-100 Sliding Channel Cover Profile



SPTS-100 Top and Bottom Channel



SPTS-100 Vertical Profile



SPTS-100 Adjustable Pin Connector for Frame



SPT-100 Sliding Profile



SPT-100 Sliding Profile



SPT-100 Profile Corner Joiner



SPTS-100 Profile Sliding Handle



SPTS-100 Profile Sliding Handle with Lock

Accessories for Fitting of Sliding Doors



Spider Without Fin

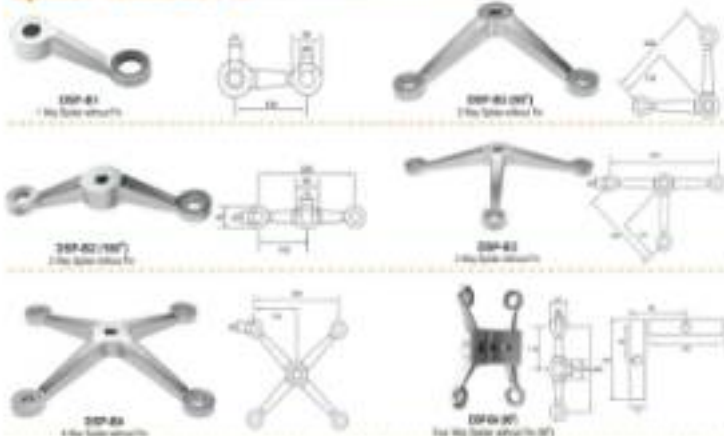

Spider With Fin

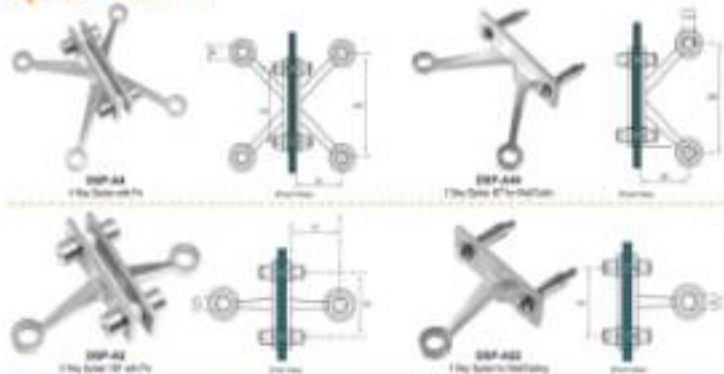

Fin Plates



DFP-200
Fin Plate (200mm)



DFP-250
Fin Plate (250mm)



DFP-300
Fin Plate (300mm)



DFP-400
Fin Plate (400mm)



Splice Plates



SSP-200
Splice Plate (200mm)



SSP-250
Splice Plate (250mm)



SSP-300
Splice Plate (300mm)



SSP-400
Splice Plate (400mm)



Routeis



DFP-APB-200
Anchor Plate



DFP-PS-200B
Anchor Plate with Counter Sink Hole



DFP-PS-FL
Anchor Plate



DSA-01
Dow Anchor



Door Handles

300mm max



20x11

Length (mm)	Width (mm)	Weight (kg)
327	360	22
462	480	22



20x12

Length (mm)	Width (mm)	Weight (kg)
325	340	20
417	350	20
600	450	20
693	630	20
940	730	20
1200	830	20



20x16 (curved)

Length (mm)	Width (mm)	Weight (kg)
32	200	20
69	300	20
346	400	20



20x17

Length (mm)	Width (mm)	Weight (kg)
417	300	22



20x18

Length (mm)	Width (mm)	Weight (kg)
460	300	20
600	400	20



20x18-1

Length (mm)	Width (mm)	Weight (kg)
470	300	20/20
550	400	20/20

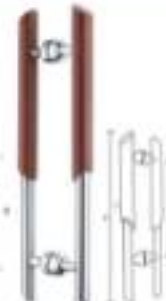

20x18-2

Length (mm)	Width (mm)	Weight (kg)
470	300	20/20



20x18-3

Length (mm)	Width (mm)	Weight (kg)
500	300	20

Door Handles

AM Glass Excel Series



204-400-01

Length	Width	Mounting Hole Spacing
527	102	26/26
491	140	26/26

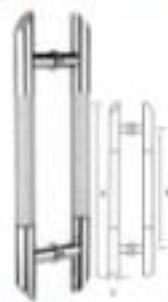

204-410-01

Length	Width	Mounting Hole Spacing
491	102	26
527	140	26



204-420-01

Length	Width	Mounting Hole Spacing
491	102	26
527	140	26



204-51

527

140

Shower Handle

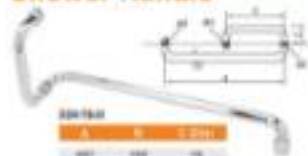

204-19-01

527 102 26

491 140 26



204-19-02

527 102 26

491 140 26

Door Knobs



204-1

Door Knob



204-2

Door Knob



204-3

Door Knob



Glass Railing Accessories



SSA-1
Post to Glass Holder



SSA-2
Post to Glass Holder



SSA-3
Post to Glass Holder



SSA-4
Post to Glass Holder



SSA-1/2041
Post to Glass Holder



SSA-5
Glass to Bracket Connector



SSA-6
Glass to Bracket Connector



SSA-7
Glass Connector for Bracket with Pin Slot



SSA-8
Glass Connector for Bracket with Round Slot



SSA-9
End to Glass Holder

Aluminium glazing profile and 'U' Channel



SSP-1
Extruding Aluminium Glazing Profile

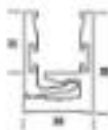

Specification:
Material: Aluminium
Type: 6063 T5 (Anodized)
Size: 3 x 43 x 18



SSP-2
'U' Channel Pin Thread Glass Channel
Colour: CP 05
Available in 3 m/6 m. Thickness: 1.5mm



Fixed Profile



SSP-101
Glass Edge Profile (Black)



SSP-102
Glass Edge Profile (Polished)



Mini Hinges



SSM-1
End to Glass Hinge



SSM-2
Glass to Glass Hinge



SSM-3
End to Glass Hinge



SSM-4
Glass to Glass Hinge



SSM-5
End to Glass Hinge
(4 Arms) (15mm)



SSM-1
Bracket End Hinge
(15-12mm)



SSM-2
Bracket End Hinge
(15-12mm)

Bracket Shell Holders

SS Friction Stay Hinge



Adjust Size 7", 10", 12", 14", 16", 18", 20", 24"

Aluminium Door & Window Handle



2022S-01
Lever Handle



2022S-02
Cylinder Handle



2022S-04
Lever Handle-Short

Self Tapping Screws



2VL-1C
Glass Lifter with Top Cap



2VL-2C
Glass Lifter with Top Cap



2VL-3C
Glass Lifter with Top Cap

DOUBLE SIDED STRUCTURAL GLAZING TAPE

Glazing Double Side Tape

- 100% High Performance Ethyl Acrylate adhesive and butyl inner layer
- High strength glue for excellent bond stability
- High modulus adhesive strength
- Excellent adhesion
- High performance, permanent bonding

Applications

- Bonding glass to frame, panes, glass-to-glass, window, wall systems and commercial windows
- Attachment of glass and plastic to metal and aluminium panels
- Cabinet bonding, bonding

Special Features

- Easy to assemble, no drilling, bonding, welding or screw fastening
- Excellent performance under moisture and heat
- Durable and easy to apply, saves time, labour cost and provides bonding strength
- Best for bonding to a variety of substrates like metal, plastic, glass, stainless steel, aluminium and polymer surface



Adhesive	Apply
4020/4020	Apply From
3402/4020	1 (over 8.25 mm)
2402/4020	10mm
14020	10mm-15mm
4020/20	100 (with special system)

* Customized size available according to specific order

Door Closer



Masking Tape



2022S is a general purpose clear tape with high strength of adhesive, excellent for masking, painting, labeling, windowing etc. The adhesive surface is smooth and uniform with excellent bonding and peeling strength. It is fast, easy to apply and it is suitable for permanent labeling. Also it is fast for availability of stock for the nearest operations.



German Technology TM

GLASSEXCEL

architecture hardware



GLASSENCAL

IRREGULAR WALL MIRROR ALUMINUM FRAME

ABHISHEK
HARDWARE

BLACK BRUSH

GOLD BRUSH

BROWN BRUSH





AMH

GLASSEXCEL
AMH-3002

ROSE GOLD BRUSH

BLACK BRUSH

GOLD BRUSH



ROSE GOLD BRUSH

BLACK BRUSH

GOLD BRUSH

AMH
GLASSEXCEL
AMH-3004



RIDGE GOLD BRUSH

BLACK BRUSH

GOLD BRUSH



GLASSEKCEL

AMH-3005



RIDGE GOLD BRUSH

BLACK BRUSH

GOLD BRUSH



GLASSEXCEL™
High Quality European
AMH-3006



ROSE GOLD BRUSH

BLACK BRUSH

GOLD BRUSH

 **GLASSEKCEL**
AMH-3007



ROUGE GOLD BRUSH

BLACK BRUSH

GOLD BRUSH



GLASSEXCEL™
with 3000+ 5-star reviews
AMH-3008



ROSE GOLD BRUSH

BLACK BRUSH

GOLD BRUSH



GLASSEXCEL

AMH-3009

RISE GOLD BRUSH

BLACK BRUSH

GOLD BRUSH

AMH GLASSEKCEL™
AMH-3010



ROSE GOLD BRUSH

BLACK BRUSH

GOLD BRUSH



AMH

GLASSEXCEL

AMH-3011

ROSE GOLD BRUSH

BLACK BRUSH

GOLD BRUSH



ROUGE GOLD BRUSH

BLACK BRUSH

GOLD BRUSH



GLASSEKCEL

AMH-3013



ROSE GOLD BRUSH

BLACK BRUSH

GOLD BRUSH



GLASSEXCEL

AMH-3014



ROUGE GOLD BRUSH

BLACK BRUSH

GOLD BRUSH



ROUGE GOLD BRUSH

BLACK BRUSH

GOLD BRUSH



ROUGE GOLD BRUSH

BLACK BRUSH

GOLD BRUSH



ROUGE GOLD BRUSH

BLACK BRUSH

GOLD BRUSH



ROUGE GOLD BRUSH

BLACK BRUSH

GOLD BRUSH



GLASSEXCEL

AMH-3019



RIDGE GOLD BRUSH

BLACK BRUSH

GOLD BRUSH



GLASSEXCEL™

PROFESSIONAL BATHING

AMH-3020



ROOSRED GWOND. O

BURSHBRASH

GOLD BRUSH

AM

GLASSEXCEL

AMH-3021



ROSE GOLD BRUSH

BLACK BRUSH

GOLD BRUSH

AMH **GLASSEKCEL**
AMH-3022



RIDGE GOLD BRUSH

BLACK BRUSH

GOLD BRUSH



AM

GLASSEXCEL

AMH-3023



RIDGE GOLD BRUSH

BLACK BRUSH

GOLD BRUSH

 **GLASSEXCEL™**
AMH-3024



ROSE GOLD BRUSH

BLACK BRUSH

GOLD BRUSH



GLASSEXCEL

AMH-3025



RIDGE GOLD BRUSH

BLACK BRUSH

GOLD BRUSH



AMH

GLASSEXCEL

AMH-3026



ROUGE GOLD BRUSH

BLACK BRUSH

GOLD BRUSH

4M
GLASSEXCEL
AHM-3027

ROUGE GOLD BRUSH

BLACK BRUSH

GOLD BRUSH



GLASSEXCEL
AMH-3028



ROUGE GOLD BRUSH

BLACK BRUSH

GOLD BRUSH



GLASSEXCEL

AMH-3029



RIDGE GOLD BRUSH

BLACK BRUSH

GOLD BRUSH



CLASSEXCEL

AMH-3030



ROSE GOLD BRUSH

BLACK BRUSH

GOLD BRUSH

AMH GLASSEKCELTM
AMH-3031



ROSE GOLD BRUSH

BLACK BRUSH

GOLD BRUSH

ARCHED FULL LENGTH MIRROR

ALUMINUM ALLOY FRAME DRESSING MIRROR, GOLD



RIDGE GOLD BRUSH

BLACK BRUSH

GOLD BRUSH



AMH

GLASSEXCEL

AMH-3032

ROSE GOLD BRUSH

BLACK BRUSH

GOLD BRUSH



EXQUISITE CRAFT

ALUMINUM ALLOY

—
SLIPING AND STURDY

Main Material:
Aluminum Alloy

Premium process:
sturdy and durable

AMH

GLASSEXCEL

AMH-3033



RIDGE GOLD BRUSH

BLACK BRUSH

GOLD BRUSH





GLASSEKCEL

ROSE GOLD BRUSH

BLACK BRUSH

GOLD BRUSH



AMH
GLASSEXCEL
AMH-3035

RISE GOLD BRUSH

BLACK BRUSH

GOLD BRUSH



AM2

GLASSEXCEL

AMH-3036



ROUGE GOLD BRUSH

BLACK BRUSH

GOLD BRUSH



GLASSEKCEL

AMH-3037



ROSE GOLD BRUSH

BLACK BRUSH

GOLD BRUSH



ROSE GOLD BRUSH

BLACK BRUSH

GOLD BRUSH



GLASSEKCEL
AMH-3039



ROUGE GOLD BRUSH

BLACK BRUSH

GOLD BRUSH

AMH-3040



ROSE GOLD BRUSH

BLACK BRUSH

GOLD BRUSH



AMH

GLASSEXCEL

AMH-3041



ROSE GOLD BRUSH

BLACK BRUSH

GOLD BRUSH



GLASSEXCEL
AMH-3042



EDGE GOLD BRUSH

BLACK BRUSH

GOLD BRUSH



ROUGE GOLD BRUSH

BLACK BRUSH

GOLD BRUSH



GLASS ALL MATERIYAL

ABHISHEK MARKETING

MaxjidStreet, No,369 10thMain Road
Akiyeppe Garden MohanKumar
Nagar Yeswanthpur,Bangaluru-
560054(Karnataka)

Email: abhishekmarketing68@gmail.com

GSTIN: 29BR0PK0076L 1Z8

State: 29-Karnataka

phone no 9457704286 +9191056 57043

ABHISHEK HARDWARE

GROUND FLOOR , NO 14/1 SHOPNO:115T
MAIN ROAD,ASTREET, NEW GUDDABAHALLI,
BENGALURU PINCODE 560-026

Email: abhishekhhardware9@gmail.com

GSTIN: 29AUJPK8529P 1ZM

State: 29-Karnataka

Phone no.: 9579908256 , 874805126

GLASS ETCHING STICKER ROLL



PRODUCT	Item	SIZE (45 MTR)
	Sticker Roll Clear	20" C-0 20" C-1 20" C-2 25" C-1 25" C-2
	Green Sticker Roll 1	20" G-1 20" G Super 20" G-2 25" G-1 25" G Super 25" G-2
	Milky Sticker Roll 1	20" M-1 24" M-1
	Plotter Roll	20" P-1 Plotter 20" P-2 Plotter 25" P-2 Plotter 25" P-4 Plotter 30" P-2 Plotter
	Plotter Roll	20" G-1 Plotter 20" Super Plotter 25" G-1 Plotter 25" Super Plotter
	Protection Roll	24inch



PRODUCT

Item

QTY



Vardhman
Colour

1 00ml



Vardhman
Colour

500ml



Moon
&
Colour

500ml



MannatWhite
MannatBlack
MannatSilver
MannatBrown
Mannat Red

1ltr



Pearl
Powder

1 00gms



Rainbow
Sparkle

100gms



Silver
Sparkle

1
00gms

GLASS CUTTER

PRODUCT

Item

Qty



Glassics

10pcs /box



TC-17

6pc/box



Glassics
Zest -100

10pcs/box



TC-30

6pc/box



Kalli

20pcs/box



N-zone

10pc/box



Rautdiamond cutter

12pcs/box

GLASS CUTTER

PRODUCT

Item

Qty



Shree diamond cutter

12pc/box



K starDiamond cutter

20pc/box



Divine glass cutter

12pc/box



KCG-88

10Pcs/Box



KCG-36

12Pcs/Box

KCG-
44

12Pcs/Box



KCG

12Pcs/Bo

-

x

GLASS CUTTER







PRODUCT	Item	Qty
	KCG-B7B6	12PCS/1BOX
	XY-3	10PCS/1BOX
	ZEST-100	10PCS/1BOX
	KCG Diamond GlassCutter Plastic Handle	10PCS/1BOX
	TC-90	6PCS/1BOX
	TC-96	6PCS/1BOX
	LibaGlass Cutter	10pcs/box

PRODUCT	Item	Description
	Pencil slim Driver	2amp 3amp 5amp
	Ultra Slim Driver	2amp 3amp 5amp 10amp 15amp 25amp 33amp
	Led Strips	120bulbs ,240bulbs (white,warm white,natural white,red blue,green,pink)
	3in 1 Led Strip	RGB (Red, Green , Blue) Warmwhite/ white/Natural White
	Mirror Touch Sensor	36watts 60watts
	2 pinplug wire	1.5mtr 2mtr
	Diamonds	Acrylic/ Glass
	LED Bulbs	3 in 1 LED bulbs

GLASS CUTTER

PRODUCT	Item	Qty
	FL-999 Dabble Head	20PCS/1BOX
	New Glass Cutter	5PCS/1BOX
	T Cutter Head	1Pcs
	Hammer	1 Pcs
	Round Cutter Head	1 Pcs
	RoundCutter Vaccum	1 Pcs
	Yellow Campos	7.5" 9"

GLASS PLIER

PRODUCT	Item	Size
	Plier	8mm
	Plier	8mm 12mm 19mm V
	Plier	8mm 12mm
	Plier	No-1 No-2 No-3 No-4
	Stand Glass Plier	-----
	UV Light	12Inche S 24Inche
	Speed Control Regulator	S 1Pc

GLASS T CUTTER

PRODUCT	Item	Qty
	T Cutter	24"
		30"
		36"
		48"
		60"
		72"
	Round Cutter	6"
		12"
		18"
		24"
		30"
		36"
		48"

GLASS Clamp and Table Cutter

PRODUCT	Item	Qty
	Table Cutter	1 Pcs
	Clamp	1 Pcs

Glass Clamp

PRODUCT

Item

Qty



Clamp

GLASS DRILL BITT

PRODUCT

Item

Qty



Drill Bitts

5mm
6mm
8mm
10mm
12mm
14mm
15mm
16mm
18mm
19mm
20mm
22mm
24mm
25mm
26mm
28mm
30mm
32mm
35mm
36mm



Drill Bitts

GLASS DRILL BITT

PRODUCT	Item	Qty
	Drill Bitts	24PCS
		24PCS
		24PCS
		16PCS
		12PCS
		12PCS
		12PCS
		10PCS
		10PCS
		
10PCS		
10PCS		
10PCS		
10PCS		
10PCS		
10PCS		
10PCS		
10PCS		
10PCS		
	Drill Bitts	10PCS
		10PCS
		10PCS
		10PCS
		10PCS
		10PCS
		10PCS
		10PCS
	Counter Sink	

GLASS VACCUM LIFTER

PRODUCT	Item	Qty
	1 cup lifter	1pc
	2 Lifter	1 pair
	3 cup silver lifter	1pair
	Heavy duty 3 cup lifter	1pair
	Heavy duty 3 cup lifter	1pair
	Black 3 cup lifter	1pair

VACCUM LIFTER

PRODUCT	Item	Qty
	Yuri 3 Cup Lifter	1 Pcs
	GlassX	1 Pcs
	3 Cup Lifter (Plastic Body)	1PCS
	Lifter Pad	1PCS
	T Cutter Round Wheel	1PCS

Diamond Tools

PRODUCT

Item

Qty

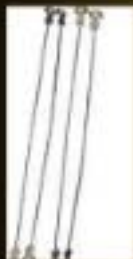

Electroplated
DiamondWire



Electroplated Diamond
Blade

110mm



Electroplated Diamond
Round File

6mm
8mm
12mm



Half Round File

6mm
8mm
12mm



ElectroplatedDiamond
Half Round File

6mm
8mm
12mm



Blk

Electroplated Diamond
Blade

85mm

Grinding Wheel



GLASSEXCEL
GLASS & CERAMIC SOLUTIONS

PRODUCT

Item

Qty

7mm C-36
 7mm C-46
 7mm C-60
 7mm C-80
 8mm C-36
 8mm C-46
 8mm C-60
 8mm C-80
 9mm C-36
 9mm C-46
 9mm C-60
 9mm C-80



**GRINDING
 WHEEL**



**SUPER CUT
 FLAP WHEEL**

#80



4" FELT WHEEL

12mm
 thick
 25mm
 thick



Flexi Cut Belt

100x1600x180
 100x1800x180
 150x1800x180
 150x1800x220



Super Cut Belt

100x1600x180
 100x1800x180
 150x1800x180
 150x1800x220



Deerfus Belt

100x1600x100
 100x1600x180

VACCUM LIFTER

PRODUCT

Item

Qty



Cup Lifter

1 Pcs

GLASS POLISH POWDER



Micro Wax

1 KG



Green Polish
Powder

1KG



Pink Polish
Powder

1KG



Glass Cleaning
Powder

2KG



White Acid Powder

1KG

GLASS POLISH POWDER

PRODUCT

Item

Qty



Black Japan

10
r
30t
r



H/F 60%

1 Carbon



KCG Blade

1 Box



Dorca Blade

1 Box



Ceramic Nozzle

1 Pcs

GLASS BREAKER



GLASSEXCEL
Jamaica's Glass Specialist

PRODUCT

Item

Qty



Glass Breaker

1 Pcs



Green Glass
Breaker

1PCS



Breaker

1PCS



Chipper

1pcs



Mini Circular saw

1pc



Bosch Grinder

1pc

GLASS UV Glue

PRODUCT

Item

Qty

UvGlue 25 Ltr

1 Carton



Uv Glue 2 Ltr

10PCS/1BOX



Uv Glue 250 ml

50PCS/1BOX



FIXOLITE Uv Glue 100 ml

100PCS/1BOX

HAND GLOVES



Hand Gloves white

1 Pair



Hand Gloves orange

1 Pair

HAND GLOVES and SPRAY GUN

PRODUCT

Item

Qty



Arm Guard

1 Pair



Sand
Blasting Gun

1Pcs



Pilot Gun

S-68 S-64 S-59



Fine Spray Painting Gun



Art Master AC-30 Pen Gun



Art Master AC-60 Pen Gun

1BOX

SPRAY GUN

PRODUCT

Item

Qty



Jianli Colour Gun

1 Pcs



Silicon Gun

1Pcs



Uv Glue
250 ml

1Pcs



MIRROR
Frame

6 x 6 8 x 8 12 x 12

NAMDA (FELT)



18" Round Namda

1"
1.5"









Table Mate

8mm (5'x 9') 12mm
(5'x9')

RESIN BONDED WHEEL

PRODUCT	Item	Size
	Resin Bonded Wheel	(175 x 12 x 12 x 15 # 240)
	Resin Bonded Wheel	(150 x 12 x 12 x 15 # 240) (150 x 12 x 10 x 12 # 240)
	Resin Bonded Wheel	(130 x 12 x 12 x 15 #240) (130 x 12 x 10 x 12 #240)
	10540 10560 10580	150 X 70 X 40
	10540 10560 10580	130 X 70 X 40
	X3000	150mm
	X5000	150mm

BEVELLING WHEEL

PRODUCT	Item	Size	
	Out Side Segmented Diamond Wheel	(150 x 12 x 10 x 8 # 100)	
	In Side Segmented Diamond Wheel	(150 x 12 x 10 x 8 # 240)	
	Cup Diamond Wheel	(150 x 12 x 5 x 10 # 100)	
	Cup Diamond Wheel	(150 x 12 x 5 x 10 # 240)	
	Beveling Resin Wheel Yellow Water Throwers		Po-3 Po-4 Po-5 Po-6 Po-7
	Beveling Resin Wheel Blue		Po-3 Po-4 Po-5 Po-6 Po-7
	Beveling Resin Wheel Aluminum Facement		Po-3 Po-4 Po-5 Po-6

BEVELLING WHEEL

CW	Item	Size
	Beveling Wheel Grey	Po -3
		Po -4
		Po -5
		Po -6
		Po -7
	Beveling Wheel Brown	Po -3
		Po -4
		Po -5
		Po -6
		Po -7
	Felt wheel	(150 x 25 x 100) (150 x 40 x 70) (185 x 35 x 115) (175 x 30 x 115)

CERIUM POWDER

	Cerium White	5kg
	Cerium Pink	5kg

Glass Polish Powder



PRODUCT

Item

Size



Diamond Pencil Edge Wheel

150 x 22 x 5.5mm#100 150 x 22 x
3.5mm#150 150 x 22 x 3.5mm#200



Diamond Pencil Edge Wheel

150 x 22 x 4mm#100 150 x 22 x
4mm#150 150 x 22 x 4mm#200



Diamond Pencil Edge Wheel

150 x 22 x 5mm#100 150 x 22 x
5mm#150 150 x 22 x 5mm#200



Diamond Pencil Edge Wheel

150 x 22 x 6mm#100 150 x 22 x
6mm#150 150 x 22 x 6mm#200



Diamond Pencil Edge Wheel

150 x 22 x 8mm#100 150 x 22 x
8mm#150 150 x 22 x 8mm#200



Diamond Flat Edge Wheel

150 x 22 x 4mm#100 150 x 22 x
4mm#150 150 x 22 x 4mm#200



Diamond Flat Edge Wheel

150 x 22 x 5mm#100 150 x 22 x
5mm#150 150 x 22 x 5mm#200

METAL BONDED DIAMOND WHEEL



PRODUCT

Item

Size



Diamond Flat Edge Wheel

150 x 22 x 8mm#100 150 x 22 x 8mm#110
150 x 22 x 8mm#140



Diamond Flat Edge Wheel

150 x 22 x 8mm#100 150 x 22 x
8mm#110 150 x 22 x 8mm#140



Diamond Pencil Edge Wheel

150 x 22 x 10mm#100 150 x 22 x
10mm#140



Diamond Pencil Edge Wheel

150 x 22 x 12mm#100 150 x 22 x
12mm#140



Diamond Pencil Edge Wheel

150 x 22 x 10mm#100 150 x 22 x
10mm#140



Diamond Flat Edge Wheel

150 x 22 x 10mm#100 150 x 22 x
10mm#140



Diamond Flat Edge Wheel

150 x 22 x 12mm#100 150 x 22 x
12mm#140

METAL BONDED DIAMOND WHEEL

PRODUCT

Item

Size



Diamond FlatEdge Wheel

150 x 22 x 19mm#100 150 x 22 x 19mm#200



B D Wheel

150 x 22 x 15mm 150 x 22 x 20mm 150 x 22 x 25mm 150 x 22 x 30mm

GLASS TUKDI



Round Tukdi

10mm
11mm
12mm
14mm
16mm
18mm
20mm
22mm
25mm
28mm
30mm
35mm
40mm
45mm
50mm
55mm
60mm
65mm
70mm
75mm
80mm
85mm
90mm
95mm
100mm



Squer Tukdi

CNC MACHINE PARTS

PRODUCT

Item

Size



Pressure Plate

1 Pcs



Pressure Plate
With Rubber

1 Pcs



Solid Rubber

1 Pcs



Capsul Rubber

1 Pcs



Capsul Rubber

1 Pcs



Rubber Strip

1 Pcs



Small Rubber

1 Pcs

CNC MACHINE PARTS

PRODUCT	Item	Size
	130mm Bellow Rubber	1PCS
	150mm Bellow Rubber	1PCS
	Oval Bellow Rubber	1PCS
	Bellow Rubber	1PCS
	Bellow Rubber	1PCS
	Bellow Rubber	1 Pcs
	Vacuum Rubber	1 Pcs

CNC MACHINE PARTS

PRODUCT

Item

Size



Vacuum Rubber

1 Pcs



Vacuum Rubber

1 Pcs



Vacuum Rubber

1pc



Vacuum Rubber

1pc

CNC MACHINE PARTS

PRODUCT

Item

Size



Aluminum Plate

130mm



Aluminum Plate

150mm



Aluminum Pulley

130mm



Aluminum Pulley

150mm



Aluminum Pulley

160mm



Water Pipe

8mm
10mm
12mm

Brush

7
4

CNC MACHINE PARTS

PRODUCT

Item

Size



Timing Belt



Loading
Unloading
Chain



Conveyer Chain For C.P
Machine



Water Pump



Motor



Thickens Miter



Edge Dilatation Wheel

6mm
8mm
10mm
12mm
20mm

CNC MACHINE PARTS

PRODUCT	Item	Size
	Switch	
	Center Wheel	
	PU Belt For Furnace	From 10mm
	Gear	Small Big
	CNC Cutter Point	135° 145° 155° 165°
	CNC Cutter Point	135°140°155°1 65°
	CNC Cutter Point	135°145°155°1 65°

METAL BONDED DRILL BITTS

PRODUCT

Item

Size



**Metal Bonded
 Non Threaded
 Drill Bitts**

4mm
 5mm
 6mm
 8mm
 10mm
 12mm
 14mm
 16mm
 18mm
 20mm



**Metal Bonded
 Non Threaded
 Drill Bitts**

20mm
 22mm
 24mm
 26mm
 28mm
 30mm
 32mm



**Metal Bonded
 Non Threaded
 Drill Bitts**

305mm
 4
 125mm
 150mm
 175mm
 200mm
 250mm
 300mm



**Metal Bonded
 Silvic**

4mm
 5mm
 6mm
 8mm
 10mm
 12mm
 14mm
 16mm
 18mm
 19mm

METAL BONDED DRILL BITTS

PRODUCT

Item

Size



**Metal Bonded
Silvic**

20mm
in
22mm
in
24mm
in
25mm
in
26mm
in
28mm
in



**Metal Bonded
Silvic**

30mm
in
32mm
in
4 23mm2 in
45mm
4 83mm5 in
50mm
36mm
in
38mm
in



Drill Adapter

25mm
30mm
in
35mm
in

**Metal Bonded
Silvic**

METAL BONDED DRILL BITTS

PRODUCT

Item

Size



Metal Bonded
Threaded Drill
Bits

4m
m
5m
m
106m
mm
128m
mm
14m
m
15m



Metal Bonded
Threaded Drill
Bits

2m8mm
2 12 6mm
2m4mm
2 15 8mm
2m6mm
2 18 9mm
3m8mm
32mm
35mm
36mm
38mm



Metal Bonded
Threaded Drill
Bits

40mm
42mm
45mm
48mm
50mm
52mm
55mm
58mm
60mm
63mm
65mm
70mm
75mm
80mm
85mm
90mm
95mm

METAL BONDED DRILL BITTS

PRODUCT

Item

Size



Metal Bonded
Threaded Drill
Bits

100mm
m
105mm
m
110mm
m
115mm
m
120mm
m
125mm
m



Metal Bonded
Threaded Drill
Bits

40mm
m
42mm
m
45mm
m
48mm
m
50mm
m



GLASS ALL MATERIYAL

ABHISHEK MARKETING

MaxjidStreet, No,369 10thMain Road
Akiyeppe Garden MohanKumar
Nagar Yeswanthpur,Bangaluru-
560054(Karnataka)

Email: abhishekmarketing68@gmail.com

GSTIN: 29BR0PK0076L 1Z8

State: 29-Karnataka

phone no 9457704286 +9191056 57043

ABHISHEK HARDWARE

GROUND FLOOR , NO 14/1 SHOPNO:115T
MAIN ROAD,ASTREET, NEW GUDDABAHALLI,
BENGALURU PINCODE 560-026

Email: abhishekhhardware9@gmail.com

GSTIN: 29AUJPK8529P-1ZM

State: 29-Karnataka

Phone no.: 9579908256 , 874805126